

COATS®

APS 3000

Center Post Tire Changer

For servicing single piece automotive and most tubeless light truck tire/wheel assemblies.

Any other type, including tube type agricultural, require special handling. Tires identified as truck tires need to adhere to OSHA standard 1910.177.

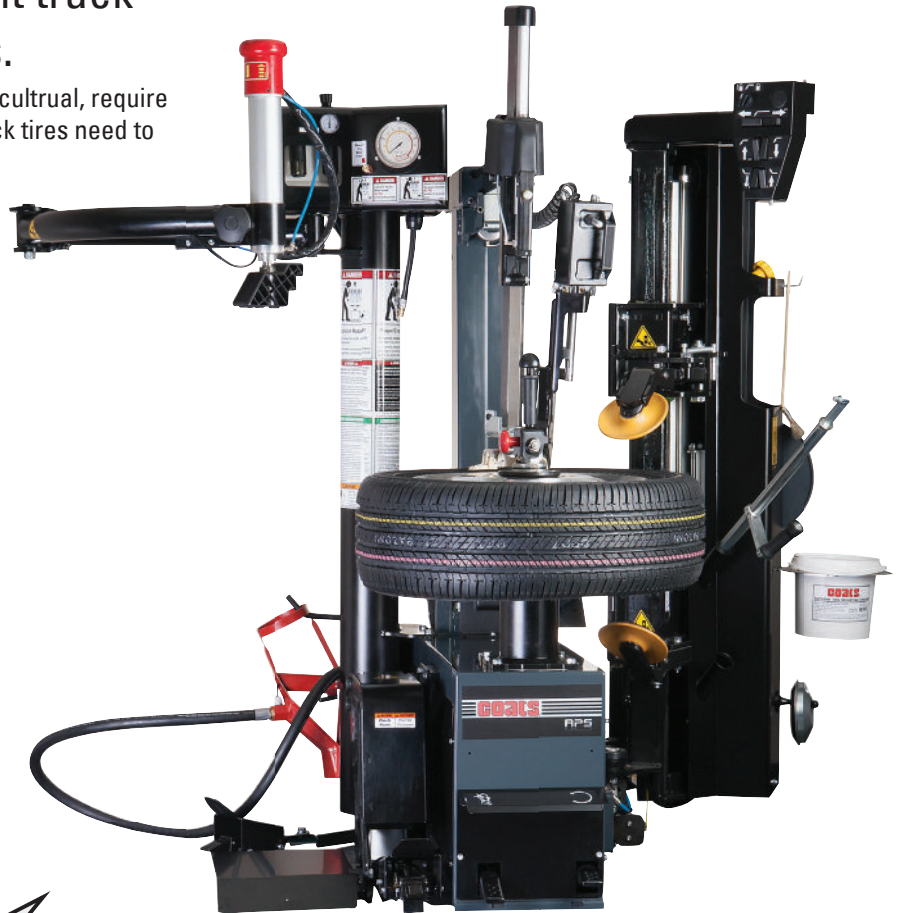

See
RIM Safety page 4
★ **Operating Instructions**
on page 6.

Safety Instructions **Set Up Instructions** **Operation Instructions** **Maintenance Instructions**

READ these instructions before placing unit in service. KEEP these and other materials delivered with the unit in a binder near the machine for ease of reference by supervisors and operators.

HENNESSY INDUSTRIES

1601 J. P. Hennessy Drive, LaVergne, TN USA 37086 615/641-7533 800/688/6359 www.coatsgarage.com
HENNESSY INDUSTRIES INC. Manufacturer of AMMCO®, COATS® and BADA® Automotive Service Equipment and Tools.

Manual Part No.: 85610910 00
Revision: 3/17

Table of Contents

General Information	iii	Upper Bead Loosening.....	15
General Safety Instructions	iii	Lower Bead Loosening	16
Tire Specifications Diagram	iv	Match Mounting.....	16
Safety Instructions	v	Tire Demounting	17
Owner's Responsibility	v	Upper Bead Demounting	17
Operator Protective Equipment	v	Lower Bead Demounting	18
Definitions of Hazard Levels.....	v	Tire Mounting	18
Specifications	vi	Lower Bead Mounting.....	18
Connections	vi	Upper Bead Mounting.....	19
Working capacity.....	vi	Inflation	20
Layout Details	vi	Stages of Inflation	21
Safety Devices	1	Mismatched Tires and Wheels	22
Safety Notices and Decals	1	Tubeless Tire Inflation.....	23
Warning Decal Placement.....	2	Standard Accessories	24
Remember R.I.M.	4	Optional Accessories	26
Principal Operating Parts	6	Maintenance	27
Pneumatic Systems	8	Standard Maintenance	27
Description of the Machine Controls	9	Machine Overhaul	28
Installation.....	9	Troubleshooting Chart	29
Space required for positioning	9	RIM Chart	32
Tire-Changer placement and connections.....	9		
Connection to the Compressed Air Supply	9		
Transport	10		
Unpacking	10		
Set Up	11		
Wheel Clamping Operation with Smart Lock	12		
Wheel Unlocking	12		
Tightening Adjustment.....	12		
Positioning the Valve	13		
Tire Classification	13		
Tire Pressure Monitoring System (TPMS)	14		
Bead Loosening	15		



General Information

The tire changer is designed to demount and mount tires of passengers cars and light commercial vehicles with rims from 10" to 34" (254 - 863 mm) and maximum tire diameter of 47" (1200 mm).

The tire changer is designed to demount and mount conventional tires, as well as new generation types, such as "self-supporting" RUN-FLAT and low profiled tires, with steel and/or light alloy rims.

The tire changer is NOT suitable for demounting inflated or dirty tires, to straighten rims or to remove wheel bead wires. As a consequence, all these procedures are FORBIDDEN.

General Safety Instructions

The tire changer is to be used exclusively by qualified and authorized personnel.

A qualified operator is someone who fully understands the instructions described in this manual supplied by the manufacturer, who has been specifically trained and who is aware of safety standards at the workplace.

Those in charge of using the machine shall not be under the influence of drugs, alcohol or other substances, which could compromise their physical and mental work capabilities.

For greater safety, operators shall wear protective footwear, gloves, protection goggles and shall NOT wear any form of clothing that could get caught in machine or restrict the operator's movements.

The operator must be able to:

- Read and understand the danger warnings.
- Understand the characteristics of the machine.
- Keep unauthorised people away from the work area.
- Make sure the machine is started in full observance of all the applicable safety standards and regulations.
- Make sure all operators are familiar with the machine and how to use it safely and correctly.
- Avoid touching moving parts or pressurised parts without first disconnecting the machine from the electrical and air power supply.
- Read and ensure full comprehension of the use and maintenance manual to be able to use the machine correctly and safely.
- Keep the use and maintenance manual with care in an easily accessible place, so that it can be consulted whenever needed.



The tire changer may only be used by specifically trained and authorized personnel.

Tampering or modifications to the equipment that are not authorised in advance by the manufacturer, relieve the latter from all forms of liability as regards to damages deriving from or referable to such actions.

Removal or tampering with the safety devices provides grounds to immediately cancel the warranty and involves violation of State and Federal OSHA regulations and codes.

The tire changer is equipped with informative and warning decals which are designed and made to last. If they should deteriorate, user may request replacement decals.

Tire Specifications Diagram

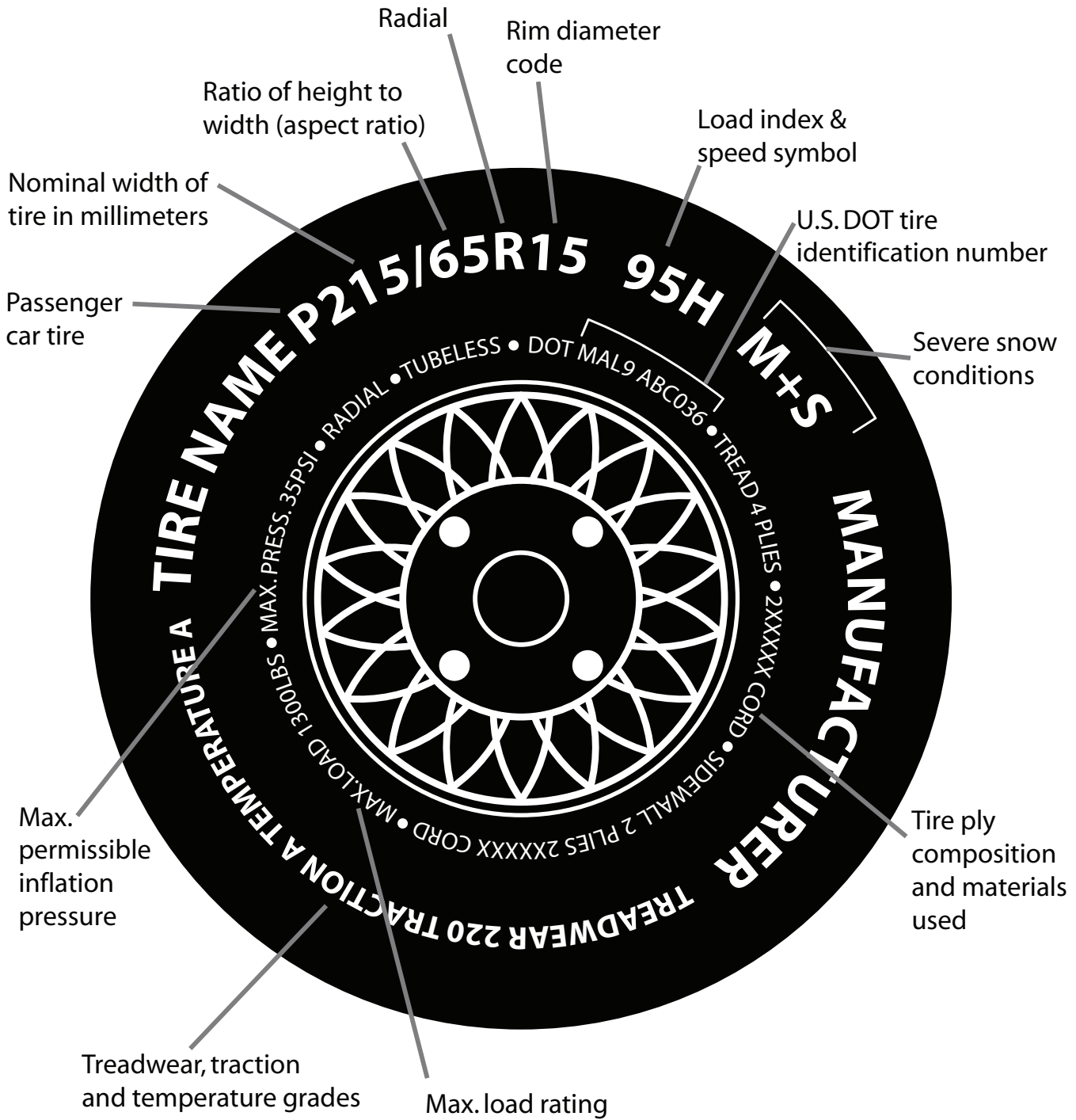

Safety Instructions

Owner's Responsibility

To maintain machine and user safety, the responsibility of the owner is to read and follow these instructions:

- Follow all installation instructions.
- Make sure installation conforms to all applicable Local, State, and Federal Codes, Rules, and Regulations; such as State, Federal OSHA Regulations and Electrical Codes.
- Carefully check the unit for correct initial function.
- Read and follow the safety instructions. Keep them readily available for machine operators.
- Make certain all operators are properly trained, know how to safely and correctly operate the unit, and are properly supervised.
- Allow unit operation only with all parts in place and operating safely.
- Carefully inspect the unit on a regular basis and perform all maintenance as required.
- Service and maintain the unit only with authorized or approved replacement parts.
- Keep all instructions permanently with the unit and all decals/labels/notices on the unit clean and visible.
- Do not override or bypass safety features.

Operator Protective Equipment

Personal protective equipment helps make tire servicing safer. However, equipment does not take the place of safe operating practices. Always wear durable work clothing during tire service activity. Loose fitting clothing should be avoided. Tight fitting leather gloves are recommended to protect operator's hands when handling worn tires and wheels. Sturdy leather work shoes with steel toes and oil resistant soles should be used by tire service personnel to help prevent injury in typical shop activities. Eye protection is essential during tire service activity. Safety glasses with side shields, goggles, or face shields are acceptable. Back belts provide support during lifting activities and are also helpful in providing operator protection. Consideration should also be given to the use of hearing protection if tire service activity is performed in an enclosed area, or if noise levels are high.

Definitions of Hazard Levels

Identify the hazard levels used in this manual with the following definitions and signal words:

DANGER

Watch for this symbol:



It Means: Immediate hazards, which will result in severe personal injury or death.

WARNING

Watch for this symbol:



It Means: Hazards or unsafe practices, which could result in severe personal injury or death.

CAUTION

Watch for this symbol:



It Means: Hazards or unsafe practices, which may result in minor personal injury or product or property damage.



Watch for this symbol! It means BE ALERT! Your safety, or the safety of others, is involved!

Specifications

Connections:

Power supply: 230V - 50/60 Hz - 1Ph
Operating pressure: 116 - 145 psi
Air supply pressure regulator set at 145 psi
Inflating air-pressure regulator set at 50 psi

Working Capacity:

Rim clamping range: 12" to 34"
Maximum rim width: 16" (406 mm)
Maximum wheel diameter: 47" (1200 mm)

Layout Details:

Minimum overall dimensions mm: 47" x 51" x 70" (1180mm x 1300mm x 1770mm)
Net weight (optional accessories excluded): 870 lb (395 kg)
Operating temperature range: **min** 41° to 122° F (5° C max 50° C)

Packing Details

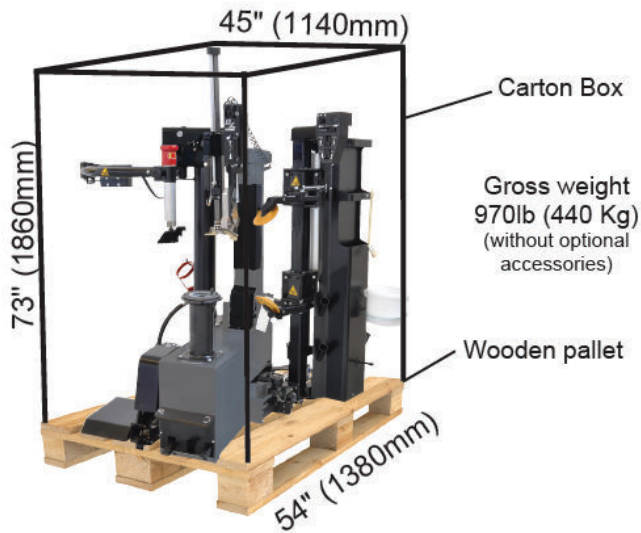

Overall Dimensions

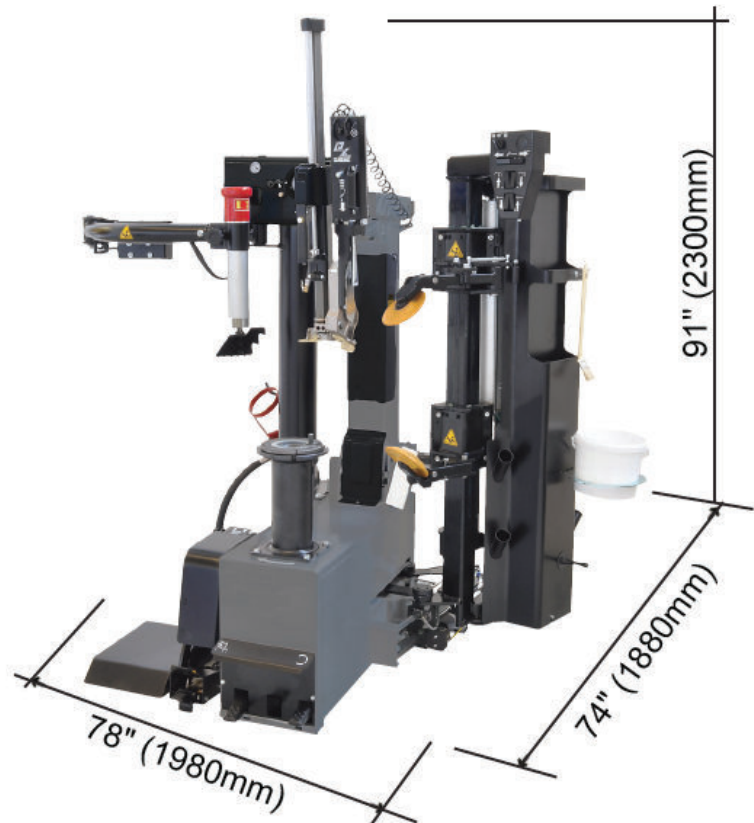

Safety Devices

The tire changer is equipped with safety devices that are designed to guarantee the safety of the machine operator:

Pneumatic safety valve, arranged inside the machine that prevents the pressure from exceeding 58 PSI during inflation.

Pressure regulator and gauge that limits the maximum pressure of the circuit to 145 PSI.

Maximum tank pressure valve, fitted on the tank, to prevent the maximum pneumatic pressure from exceeding 160 PSI (optional auxiliary bead seater)

Safety Notices and Decals



Failure to follow danger, warning, and caution instructions may lead to serious personal injury or death to operator or bystander or damage to property. Do not operate this machine until you read and understand all the dangers, warnings and cautions in this manual. For additional copies of either, or further information, contact:

Hennessy Industries, Inc.

1601 JP Hennessy Drive
LaVergne, TN 37086
(615) 641-7533 or (800) 688-6359
www.coatsgarage.com



For additional information contact:

Rubber Manufacturers Association

1400 K Street N. W., Suite 900
Washington, DC 20005
(202) 682-4800
www.rma.org

Tire Guides, Inc.

The Tire Information Center
1101-6 South Rogers Circle
Boca Raton, FL 33487
(561) 997-9229
www.tireguides.com

Warning Decal Placement

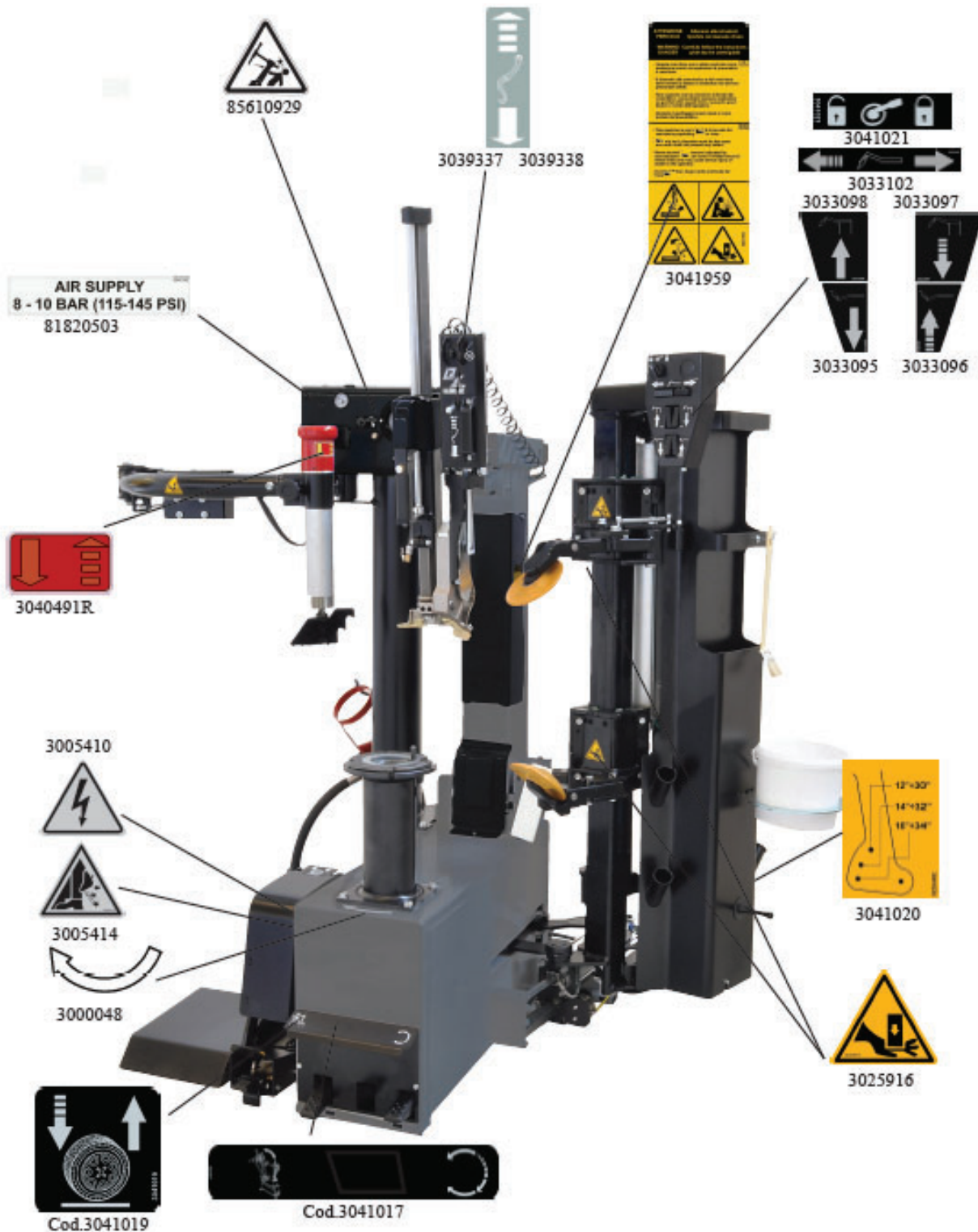

WARNING

Replace any warning label immediately in case of damage or loss.
 Do not operate the Tire Changer in case of missing warning labels.
 Do not hide any warning label by any means. Do not place objects that can obstruct or reduce the visual ability of the operator. Refer to the above mentioned codes for ordering warning labels.

Warning Decal Placement (cont.)



Main Coats
85608119
Front of the machine



Pinch Point
85610705

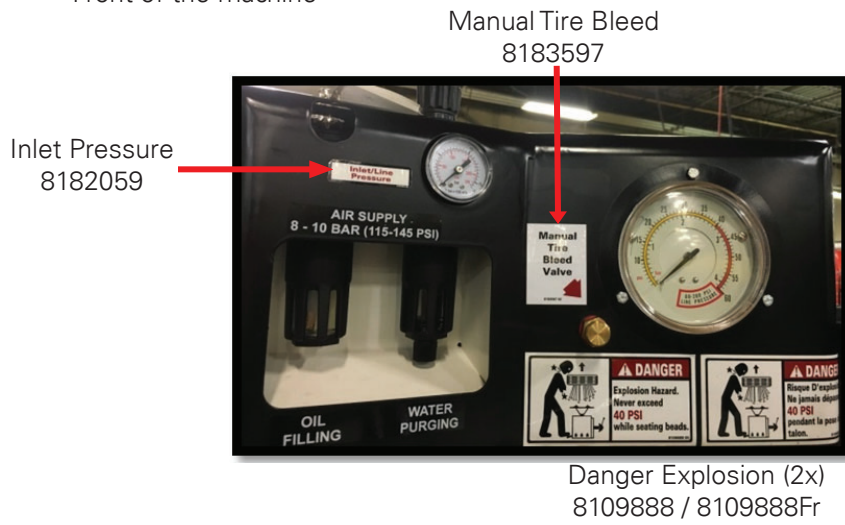

Manual Tire Bleed
8183597

Inlet Pressure
8182059

Danger Explosion (2x)
8109888 / 8109888Fr



Pinch Point
85609356



Tower
8182373 and FR

Remember R.I.M.

Three Simple Steps To Help Keep Shops Safe

READ INSPECT MOUNT

R.I.M. is a training program developed by Hennessy Industries to help keep tire technicians safe. By following the basic principles of R.I.M., technicians can avoid situations that can cause catastrophic accidents like tire explosions.

R.I.M. stands for read, inspect, and mount:

Read the tire size on a new tire before mounting to make sure it is the proper size for the wheel.

Inspect the wheel for cracks, rust, and or other damage that could cause an unsafe situation.

Mount the tire safely, making sure not to put any part of your body over the tire during inflation.

The most serious of possible accidents is a tire explosion. This is often caused by a tire/rim mismatch.

If a tire explodes on a tire changer, pressure causes it to fly straight up at tremendous speed. If a technician is standing over the tire, he can be seriously injured or killed.

Hennessy's R.I.M. program allows the technician to avoid situations that can cause tire explosions and other accidents. The full program, including training videos, brochures, posters, and other materials, are available from Coats distributors nationwide.



Intentionally left blank

Principal Operating Parts

Do It Now!

Now is a good time to contact product service (800-688-6359) to start warranty, otherwise warranty starts at time of shipment.

Know Your Unit

Compare this illustration with the unit before placing it into service. Maximum performance and safety will be obtained only when all persons using the unit are fully trained in its parts and operation. Each user should learn the function and location, of all controls.

Prevent accidents and injuries by ensuring the unit is properly installed, operated and maintained.

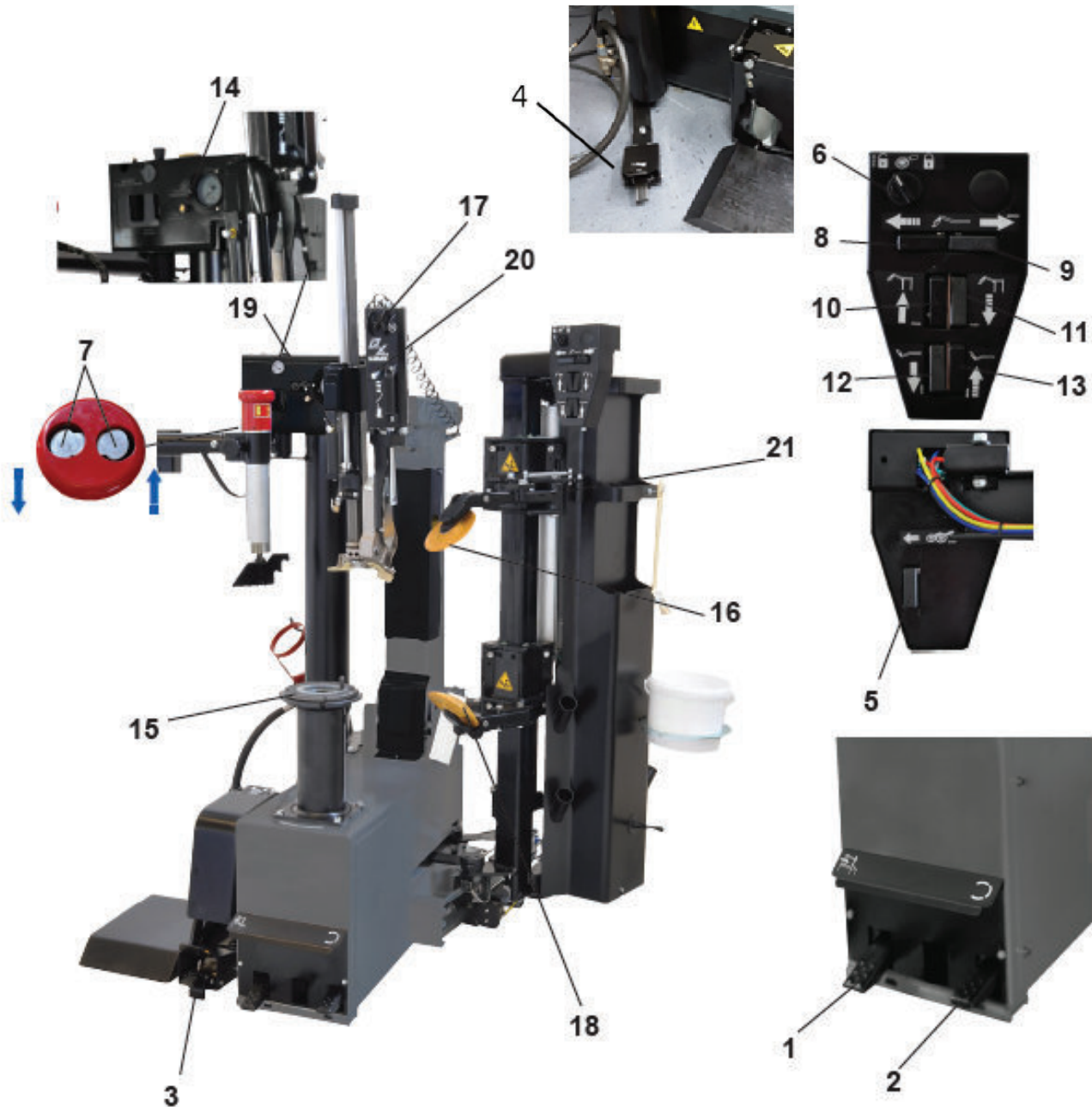



Replace any damaged or missing safety decals. They are available from COATS, (800) 688-6359.

- 1 Tilting tower control pedal
- 2 Clockwise and counterclockwise clamping chuck (15) rotation control pedal
- 3 Wheel lifter (optional) control pedal
- 4 Inflation pedal
- 5 Button used to activate the "over-run" function of bead loosener disks (16 and 18)
- 6 Selector used to block the bead breaking carriage and to activate the "over-run" function (5)
- 7 Bead pressing arm control buttons (up/down)
- 8 Bead breaking carriage "forwards" movement button
- 9 Bead breaking carriage "backwards" movement button
- 10 Upper bead loosener disk lifting button
- 11 Upper bead loosener disk lowering button
- 12 Lower bead loosener disk lowering button
- 13 Lower bead loosener disk lifting button
- 14 Deflation button
- 15 Clamping chuck
- 16 Upper bead loosener disk
- 17 Leverless mode control switch
- 18 Lower bead loosener disk
- 19 Operating arm control button
- 20 Leverless tire mounting/demounting system control switch
- 21 Upper bead loosener arm opening control

Pneumatic Systems

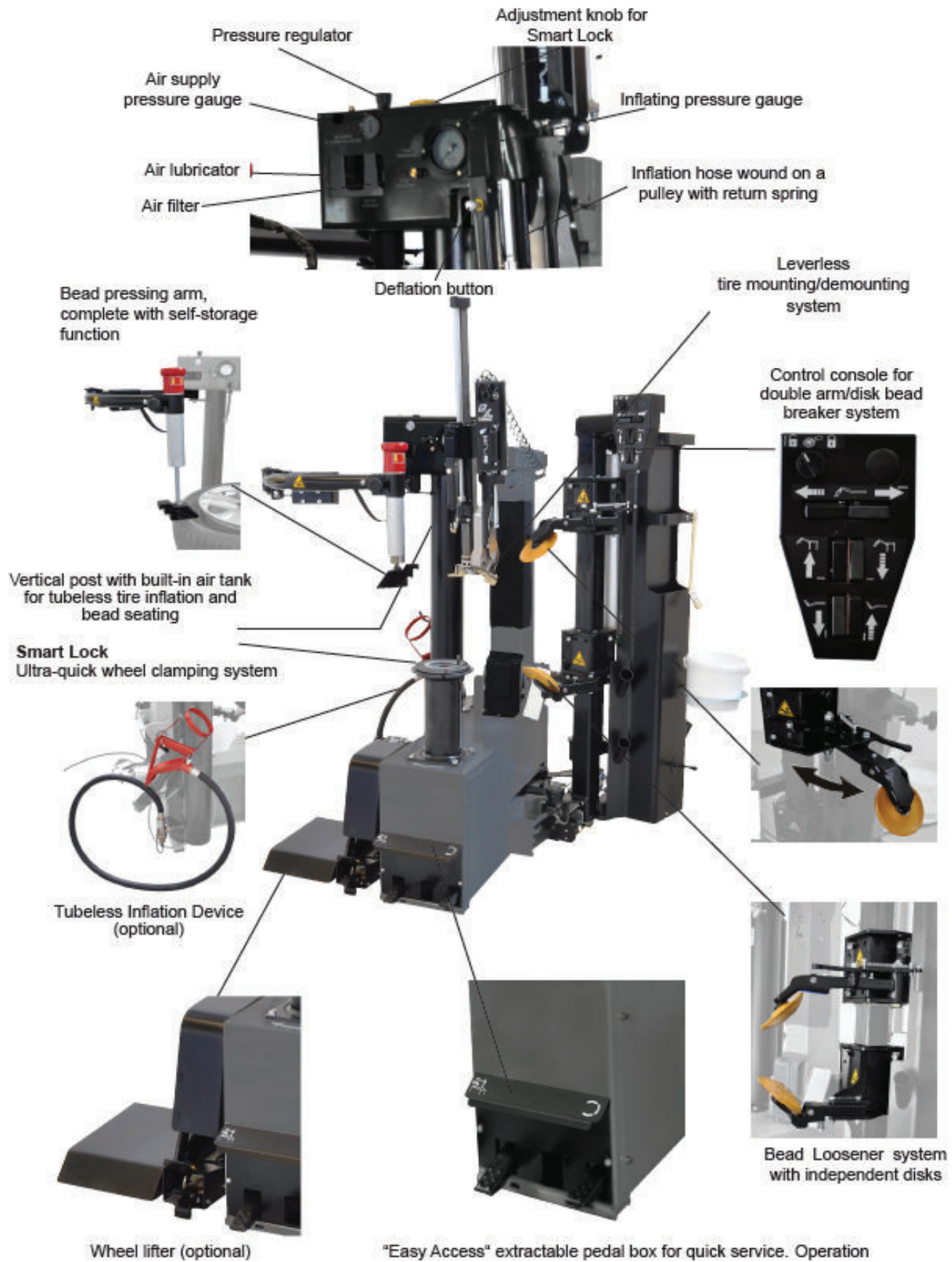

Description of the Machine Controls

Installation

Space required for positioning

When choosing the place of installation be sure that it complies with current safety-at-work regulations.

The Tire-Changer must be connected to the main electric power supply and the compressed air system. It is therefore advisable to install the machine near these power sources.

The installation area must leave at least the room shown in picture "fig. 1", so as to allow all parts of the machine to operate correctly and without any restriction.

Lighting should be adequate to perform safe operations and comply with the current regulations for safety at work.

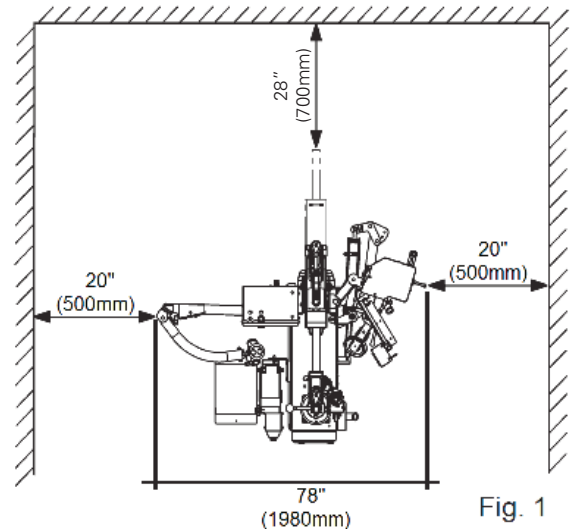

Tire-Changer placement and connections

Place Tire-Changer onto a flat, smooth and not slippery floor with a suitable load capacity.

The machine need not necessarily be anchored to the ground, but if you prefer to do so, drill 2 deep holes (100 mm) on the ground in correspondance of 2 holes of the machine rear base by using a 10 mm drill bit of suitable length. Insert the two brackets A and B into the machine base from the front, and drill two holes the same as previous ones. Insert suitable metal anchor dowels in the holes drilled and secure firmly.

If the machine is installed outside it must be protected by a appropriate lean-to shed. The installation site should be equipped with an electrical system with an adequate grounding circuit equipped with an appropriate ground fault 16A circuit breaker, power indicator light, placed in a visible and accessible place by the operator.

NOTE: If the machine is supplied without the electrical plug, the user shall install a 20A plug suitable for the voltage of the machine and complies with current regulations.



Before connecting the machine, ensure pneumatic and electrical supplies meet those indicated on the machine's data plate.

- **Even small electrical system jobs must be performed out by qualified personnel.**
- **The Manufacturer is not responsible for damages caused by electrical connection different from those on the machine's data plate.**
- **Unplug the unit from electrical and pneumatic supplies before moving and servicing.**
- **During the first connection to the compressed air, attention must be paid to the movement of certain parts of the machine, which may be sudden and unexpected, creating potential hazards in the action area.**

Connection to the Compressed Air Supply

The pneumatic supply must be a minimum of 116 psi.

Connect the machine to the compressed air supply by the quick disconnect located at the rear of the machine (Fig. 2).



Fig. 2

Transport

The Tire Changer must be transported in its original packaging and kept in the position indicated on the box.

The packaged machine must be moved with a fork lift of suitable capacity. Please insert the forks as shown in fig. 1.

Unpacking

Remove the protective cardboard, remove all fixing screw and free the Tire-Changer from its original pallet. Check the condition of the machine, making sure that no part is damaged or missing, by referring to the picture on page 10.

If in doubt, please do not use the machine and get in touch with your Distributor for further steps. Keep packing elements away from children. All packing elements must be stored in the proper stocking areas.

Note: All the most delicate surfaces of the Tire Changer are coated with a special rust-proof oil. Some oil traces may leak after coating procedure: please, remove them as necessary.

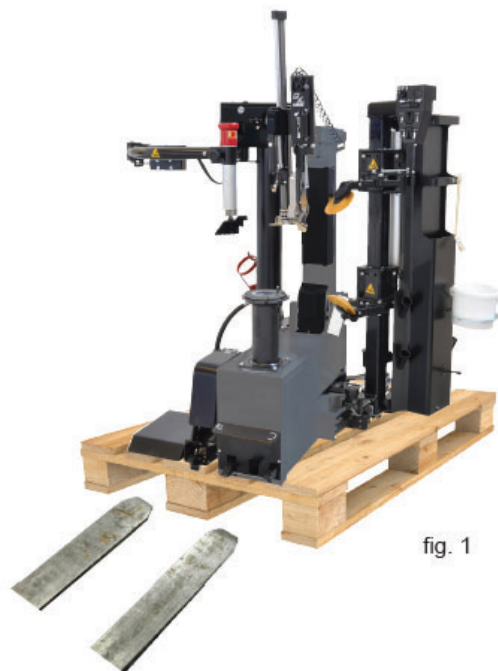

fig. 1

Gross weight
970 lbs. (440 Kg.)



fig. 2

Use lifting equipment of suitable load-bearing capacity that is able to take the weight of the tire changer. To lift the machine (fig. 2), use a transport strap with minimum load-bearing capacity of 970 lb. (440 kg).

After tire changer positioning, take off the transport strap.



Fig. 3

After having positioned the machine, in its final location, remove the accidental tilting safety pin from the arm (fig. 3).

Put the pin together with the other standard accessories delivered with the machine, for any future need.

Set Up

Connect the machine to the electrical power supply, which must have line fuses and an efficient grounding system, meeting current standards. It must also be connected to an automatic differential 20A circuit breaker.

NOTE: If the machine is not supplied with an electrical plug, the user shall install a 20A plug that is suitable for the voltage of the machine and complies with current standards.

Connect the machine to the compressed air supply using the fitting on the lubricator on the back of the machine.

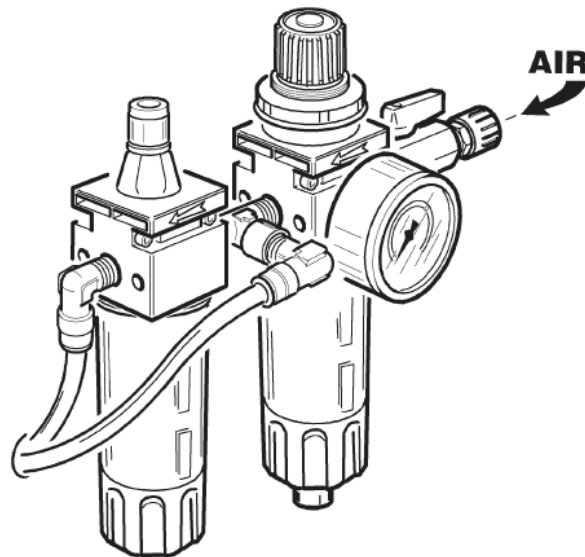

Loosen the control panel bracket locking cap screw and pivot cap screw, adjust it to a convenient position for operation, then tighten the cap screw.

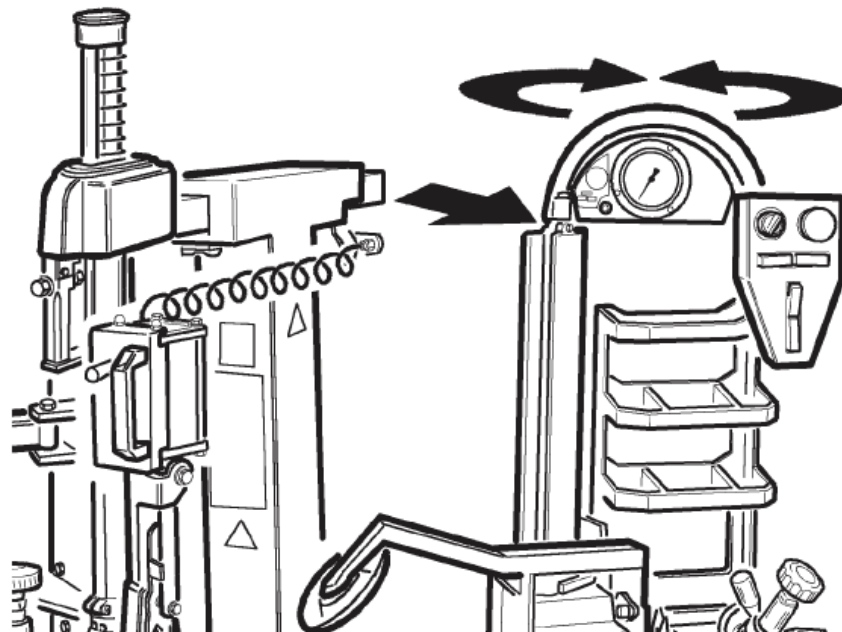

Wheel Clamping Operation with Smart Lock

1. Check the correct wheel positioning on the clamping chuck. Insert SMART LOCK making the centering cone fit the rim hole correctly, leaving no space among SMART LOCK nut, the rim and the Tire-Changer clamping chuck.
2. Keeping the handle pressed down (to avoid residual play), tilt the locking lever vertically.
3. During wheel clamping operation the Quick-Release system moves automatically to hooking position (click). Check the perfect wheel locking onto the clamping chuck before performing any head breaking, demounting or mounting operation.

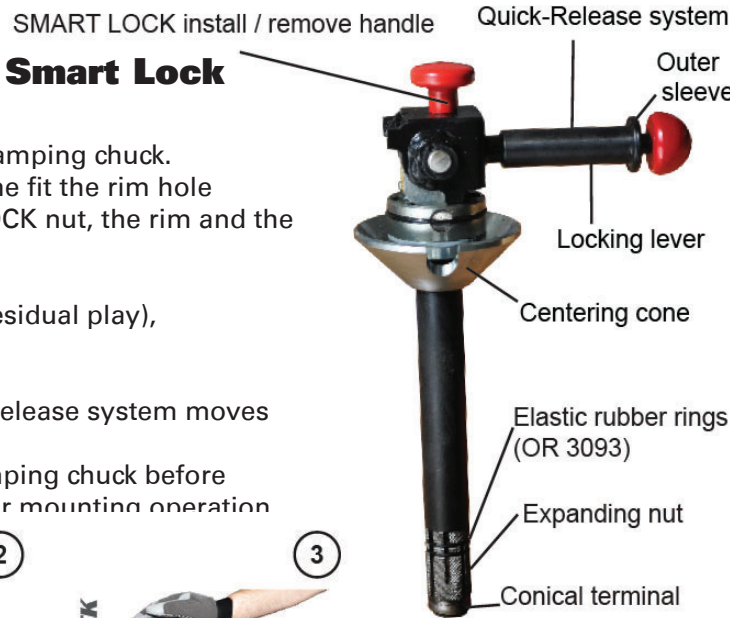

Plastic protection to avoid any damage to alloy rim



Wheel Unlocking

4. Once the operations on the wheel are completed, lift up the Quick-Release system outer sleeve.
5. Tilt down the locking lever to unlock SMART LOCK, in order to pull out the locking nut and remove the wheel from the clamping chuck.

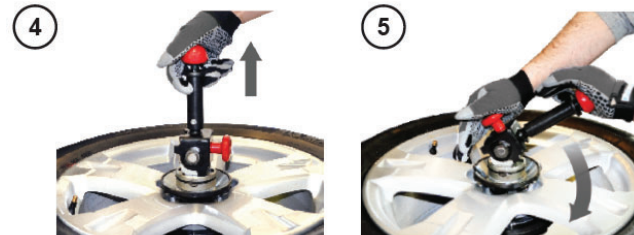

Tightening Adjustment

The clamping force of SMART LOCK could be loosened after a long time use by a progressive wearing of some components, this revealed by a progressive slack of the locking lever.

To restore / increase / decrease the SMART LOCK tightening: press the yellow adjustment button and, by means of the adjustment knob, start turning manually the conical terminal thus acting on the expanding nut. Then, release the button and keep on turning the conical terminal until the button pops up again.

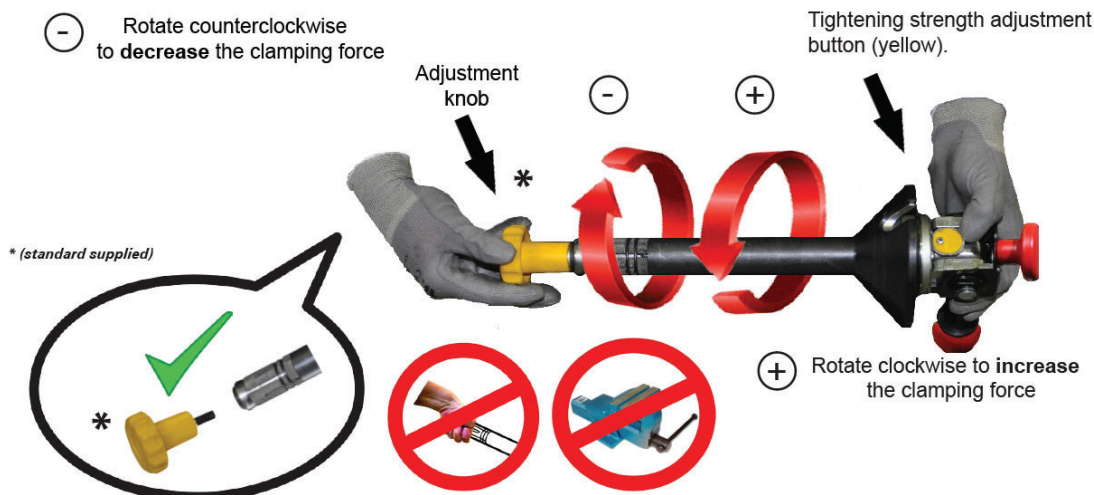

Positioning the Valve

Fig. 6 shows a rim in the form of a clock. In the following Mounting and Demounting process steps, you will position the rim with clock directions, so that the valve and pressure sensor do not get damaged.

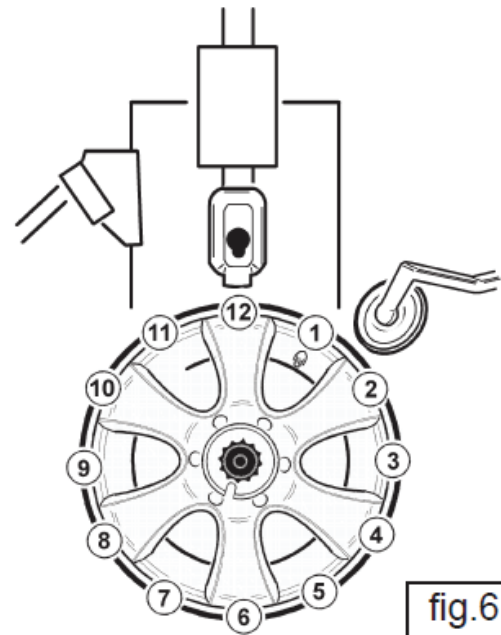

fig.6

CAUTION

To avoid damaging the valve and pressure sensor, (if installed) you must always arrange the valve in the position indicated, following the instructions when mounting and demounting the tire. fig.6

Tire Classification

LOW PROFILE tires (UHP) are those in which the height (H) and the width (C) have a ratio lower than 0.5 (i.e. low profile series 45 stands for a ratio of $H/C = 0.45$).

For tires to be considered as LOW PROFILE (UHP), they must also have a maximum speed code of equal to or higher than V.

RUN-FLAT tires are those which, even when they have no internal pressure, allow you to continue to drive the vehicle for a preset number of miles and at a preset speed. These parameters change from one manufacturer to another. The market currently offers 2 different types of RUN-FLAT tires:

- Those with REINFORCED SIDE (SELF-SUPPORTING) where, thanks to a different mix and a reinforced structure, the shoulder of the tire is able to bear the weight of the vehicle even when the pressure in the tire is zero.
- Those with INTERNAL SUPPORT have a ring inside the rim that bears the side of the tire when there is no pressure inside it. The internal support may be made of plastic or metal.

The tire changer is able to handle all types of LOW PROFILE (UHP) and all types of RUN-FLAT tires with REINFORCED SIDE; for other types, refer to the specific instructions of the dedicated accessories, if available.

The mounting and demounting procedure is the same, be it a RUN-FLAT tire with REINFORCED SIDE (SELF-SUPPORTING) or a LOW PROFILE tire (UHP).

CAUTION

It is crucial to follow the instructions very carefully in order to avoid irreparable damages to the tire, which could compromise the vehicle's safety.

Tire Pressure Monitoring System (TPMS)

TPMS, Tire Pressure Monitoring System is an electronic system designed to monitor the air pressure inside the tires through special sensors mounted inside the wheels, which provide real-time tire-pressure information and inside temperature data to the vehicle's electronic control unit. Tire pressure system alerts the driver when the tire pressure falls 20% below the recommended pressure, thus increasing your safety on the road.

This chapter describes the correct positioning of TPMS valve during the different working stages, in order to avoid any damage.

Bead Loosening:

Place TPMS valve at **"2:00 o'clock"** position.
Start pushing on the tire bead using the upper bead loosening disk.



Demounting tool positioning:

Place TPMS valve at **"2:00 o'clock"** position. Bring the demounting tool into working position. While spinning the wheel, insert the demounting tool into the drop center level. Stop tire rotation when the valve reaches 11 o'clock position.

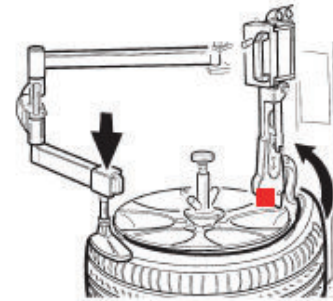
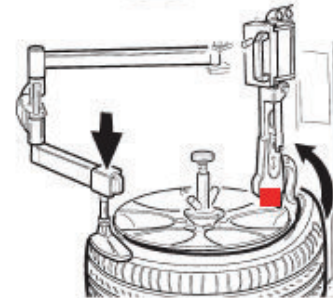

Upper Bead demounting:

Spin the clamping chuck (clockwise) by pressing pedal **1** until the valve reaches **"1 o'clock"** position (at about 10 cm from the demounting tool) so as to avoid possible damages to the TPMS valve.

Warning: Rim and Tire must spin together as one, during bead demounting operations, to avoid displacement of **TPMS** sensor.

Lower Bead demounting, with demounting tool:

Place TPMS valve below the demounting tool at **"12:00 o'clock"** position.

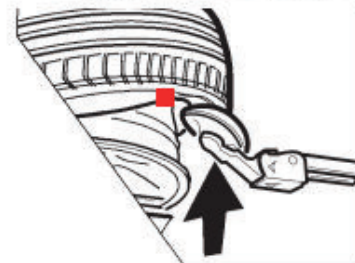

Lower Bead demounting, with bead loosening disk:

Place TPMS valve towards the bead loosening disk.

Lower Bead mounting:

Place TPMS valve at **"5:00 o'clock"** position, in any case at about 10 cm from traction point.

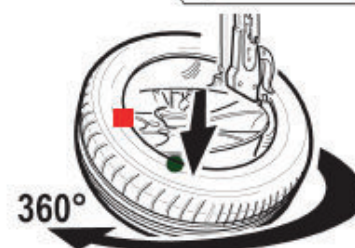

Upper Bead mounting:

Place TPMS valve at **"5:00 o'clock"** position, in any case at about 10 cm from traction point.

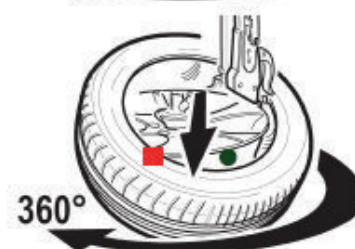

■ TPMS valve

● Traction point

Bead Loosening



Ensure the tire is completely deflated before starting any operation on the wheel.

Before lifting and positioning the wheel onto the clamping chuck, use the proper tool to remove any weights from the rim, paying attention to not damage the rim.

Before starting any operation, check for the presence of a pressure sensor. If equipped, check its operation with a dedicated diagnostic tool.

It is possible to unlock the disk support and enable a spring loaded movement, changing the angle of the disk, increasing its penetration inside the rim. Particularly effective with soft tires.

Upper Bead Loosening

Check the correct centering and locking of the wheel onto the clamping chuck. Check that the upper disk arm is in the working position.

Turn switch **6** to unlock the bead loosener and position it by pressing buttons **8, 9, 10 and 11** on the console, so that the distance between the upper disk and the rim edge is 5 mm (fig. 1), then lock the bead loosener by turning switch **6** again.



fig. 1

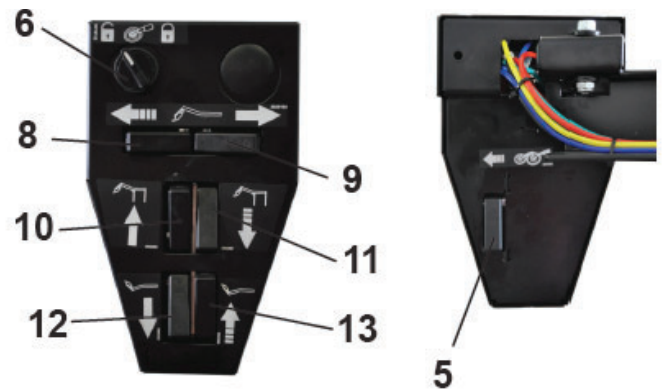

Pay special attention to the valve sensor position, if any, during bead breaking operations. Wrong movements of the bead loosening disks could damage the sensor.

Spin the clamping chuck until the valve is in the **3 o'clock** position.

Lower the bead loosener disk until it touches the tire using controls **10** for lifting and **11** for lowering.

Start spinning **clockwise**.

Note: the clamping chuck can spin at 2 different speeds, according to operator's preferences.

While spinning the wheel, push the upper bead loosener disk down below the edge of the rim, then press and hold down the "over-run" function button **5** while gradually lowering the bead loosener disk until the bead is removed from the rim.

As soon as enough space is available, a proper tire lubricating paste should be carefully applied to both the inner surface of the rim and the tire bead (fig. 2).



fig. 2



Avoid contacting pressure sensor with lube paste if installed.

Once the bead is loosened, using button **10** to raise the upper bead loosening disk and move away.

Lower Bead Loosening

Keep the bead loosener system set up as for upper bead loosener disk procedure: the lower bead loosener disk is always aligned with the upper one, and it is already positioned at **3-4 mm** from lower rim edge.

Lift the lower bead loosener disk until it touches the lower tire bead using controls **13** for lifting and **12** for lowering.

Rotate wheel **clockwise**.

While spinning the wheel, push the lower bead loosener disk up above the edge of the rim, then press and hold down the "over-run" function button **5** while gradually lifting the bead loosener disk until the bead is removed from the rim.



As soon as enough space is available, carefully apply tire lube paste to both to the rim inner surface and to the tire bead (fig. 2).

NOTE: For a better view and control of the lower bead loosening, use the mirror mounted on the main frame.

WARNING

While loosening the bead, just press on the bead and never on the side of the tire.

Match Mounting

Driving could be affected by vibrations caused by deformations of the rim and/or tire. To optimize the wheel-balancing, it is necessary to position the wheel onto the Tire Changer again to bead loosen and lubricate the rim and the tire, spinning the tire around the rim to a proper position.

Both upper and lower disks make this process easier, by gently holding the tire steady while the clamping chuck spins the rim until the correct matching position is reached.



Tire Demounting

Once the bead loosening process is completed, and the wheel is already positioned on the clamping chuck, check and ensure its locked and centered.

Upper Bead Demounting

Bring the tilting tower close to the wheel by pressing pedal **1**, while simultaneously placing the mounting tool over the rim edge using the handle (fig. 1). Set the locking button **19** to position 1 (fig. 2) to lower the operating arm, then lock everything by setting the locking button in position 2. In this way the mounting tool will automatically move to the right distance from the rim, at about 2 mm.

Rotate the clamping chuck by pressing pedal **2** until the valve is in the **"1 o'clock"** position (roughly 10 cm distance from the mounting tool) in order to avoid possible damages to the valve or pressure sensor - if equipped.

Lower the lever **20** to insert the mounting tool between the bead and the rim edge. The mounting tool should penetrate enough to hook the tire bead to let the operator complete the tire demounting.

Slowly spin the clamping chuck until the mounting tool is positioned correctly. This will facilitate mounting tool penetration and tire hooking.

By gently pushing the lower bead loosener disk against the tire lower sidewall and the pneumatic bead pressing arm against the upper sidewall at the **"6 o'clock"** position, it will be easier to fit the tool into position (fig. 4).

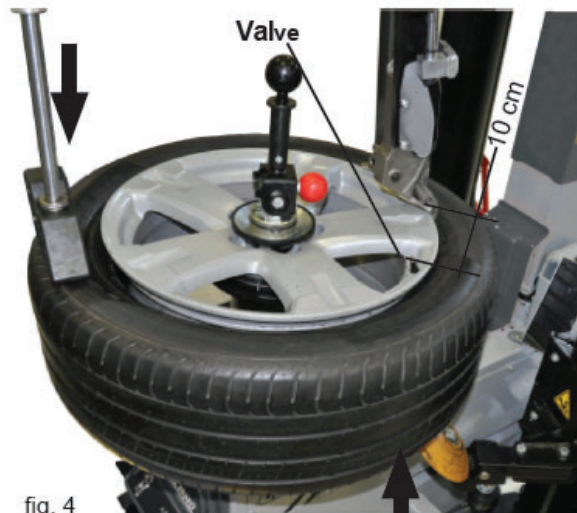
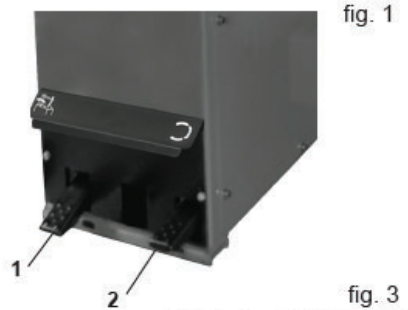
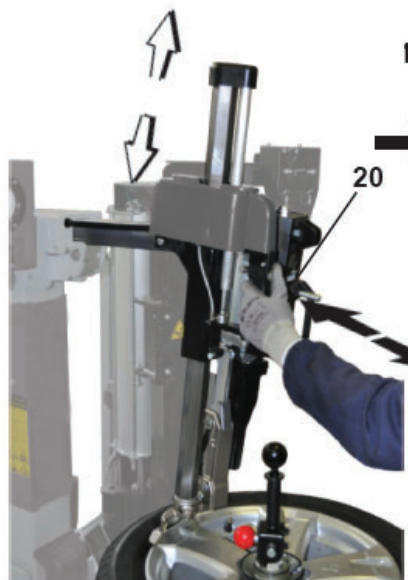
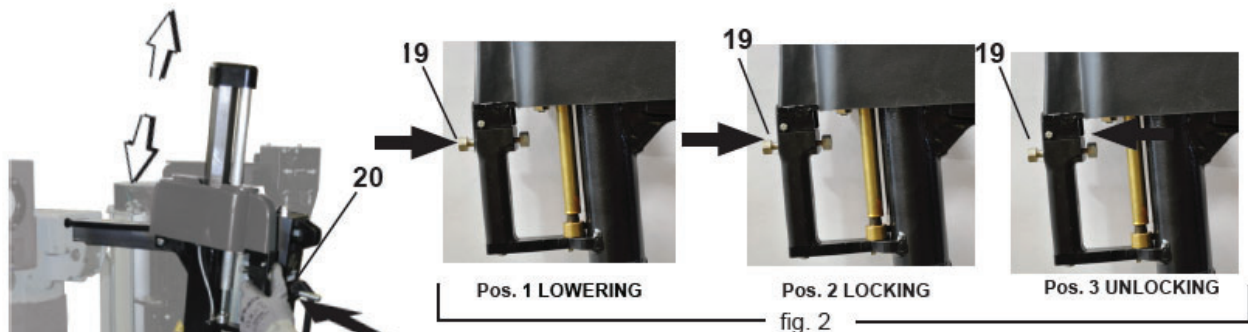

As soon as the bead is perfectly hooked, lift the mounting tool using the lever **20** to pull out the bead.

To make the lifting easier, set the bead pressing arm at **"6 o'clock"** position and press the sidewall (fig. 4) using pneumatic bead pressing arm.

Press down pedal **2** to rotate the wheel clockwise until the upper bead is completely off the wheel rim.

NOTE: Rim and Tire must spin together as one. To help the upper bead off the Rim and reduce the stress to the Tire, insert the plastic lever (fig. 5) and spin the wheel clockwise while lifting the tire with the lower bead loosener disk.

Lower Bead Demounting

Press pedal **1** to move the mounting arm away from the working position.

Before pulling out the lower bead, spin the clamping chuck to let the valve reach **"1"** or **"2"** o'clock position in order to avoid possible damages to the valve and the pressor sensor - if equipped.

Raise the lower bead loosening disk to lift the tire until the lower bead is **1 cm** over the upper rim edge (fig. 1).

Spin the wheel clockwise until the tire is completely off Rim.

Check the pressure sensor - if equipped - and replace if necessary.

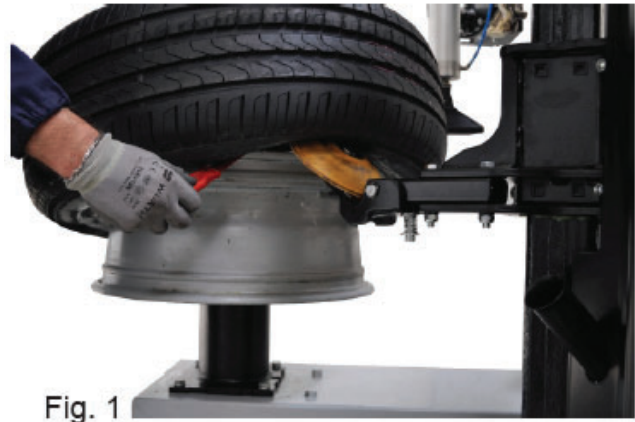

Fig. 1

NOTE: Rim and Tire must spin together as one.

To help the lower bead off the Rim and reduce the stress to the Tire, insert the plastic lever and spin the wheel clockwise while lifting the tire by the lower bead loosener disk.



Tire Mounting

Check the rim and the tire carefully, as per instructions on pg. 4.

If the rim has been removed, lock it again onto the center plate per instructions on pg. 12.

Carefully lubricate the whole inner surface of the Rim and the beads of the Tire, both externally and internally around the circumference, for a width of at least 3 cm.



Avoid contacting pressure sensor with lube paste if equipped.

Lower Bead Mounting

Put the Tire on the Rim with it tilted at **"12 o'clock"** position in order to make both upper and lower beads go under the upper rim edge.

Press pedal **1** to approach the mounting arm and position the mounting / demounting tool on the Rim edge.

Incline the tire down at the **"3 o'clock"** position, driving the lower bead on the mounting tool in order to put the lower bead over its left side and under it on its right side.

Rotate the wheel clockwise by pressing the pedal **2**, while pressing the tire manually at **"5 o'clock"** position until the lower bead reaches the drop center level. Keep the tire pressed while rotating up to **"8 o'clock"** position to complete the lower bead mounting.



Upper Bead Mounting

Keep the mounting arm and the mounting tool in working position and proceed with mounting of the upper bead, then put the tire bead on the rim slightly tilted down to **"3 o'clock"** position, so that the upper bead rests on the left side and under the right side of the mounting tool (fig. 1).



fig. 1
Bead correctly positioned over the left side of the mounting tool and under it on its right side.



fig. 2
Bead correctly positioned over the left side of the mounting tool and under it on its right side, thus it can be slightly lowered for easy tire mounting.



fig. 3
Press the pedal **2** to rotate the wheel clockwise, contemporarily press the tire manually from **"5 o'clock"** position to force the upper bead at drop-centre position. Keep it pressed while rotating up to **"8 o'clock"** position to complete the upper bead mounting (fig. 2).



fig. 4
It is advisable to use the pneumatic bead pressing arm (fig.2) for standard tires that are particularly difficult to bead loosen. (fig. 3).

Press the buttons (fig. 4) to use using the bead pressing tool to push on the tire bead at **"5 o'clock"** position, press pedal **2** and rotate the tire until it is completely mounted. Once the bead has been mounted, the bead pressing tool will automatically return to the rest position.



WARNING

Ensure that the Rim and Tire always spin together.

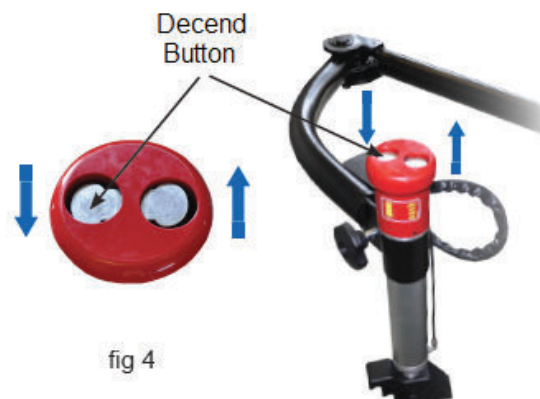

fig 4

Inflation



NEVER exceed tire manufacturer's recommended air pressure. Tires can explode, especially if inflated beyond these limits. Use clip-on air chuck, keep hands, arms and entire body back from inflating tire. Avoid distraction during inflation. Check tire pressure frequently to avoid over inflation. Excessive pressure can cause tires to explode, causing serious injury or death to operator or bystander.



If you change tires defined as truck tires, they must be inflated per OSHA instructions.

1. Ensure both beads are seated. When both beads are seated, the tire is ready for inflation.
2. Replace the valve core if it was removed.
3. Depress the inflation pedal to position 2 to inflate the tire. The pressure limiter will cycle the air flow as described earlier. On most tires, the pressure limiter will cease air flow at approximately 60 PSI. On smaller volume tires the pressure may be higher.
4. Release air pressure from tire by pressing the manual deflation button (fig. 27). Inflation hose must be attached to the valve stem. Never add or adjust tire pressure using an air hose without a clip-on air chuck and in-line valve. Do not use a hand-held style chuck (figure 28).
5. **Important:** When inflating tires that require more than 60 PSI, always use a safety cage and air hose with a clip-on air chuck and in-line valve. The air hose must have enough length between the chuck and the operation/in-line valve to allow the operator to stand outside the trajectory.

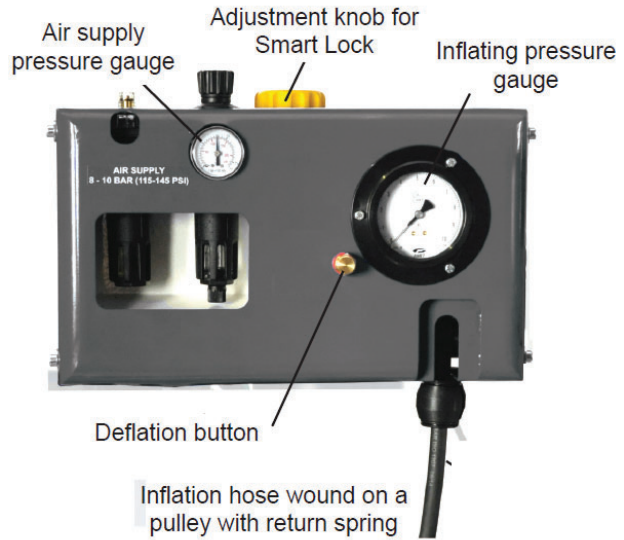

Figure 27 - Location of Deflation Button

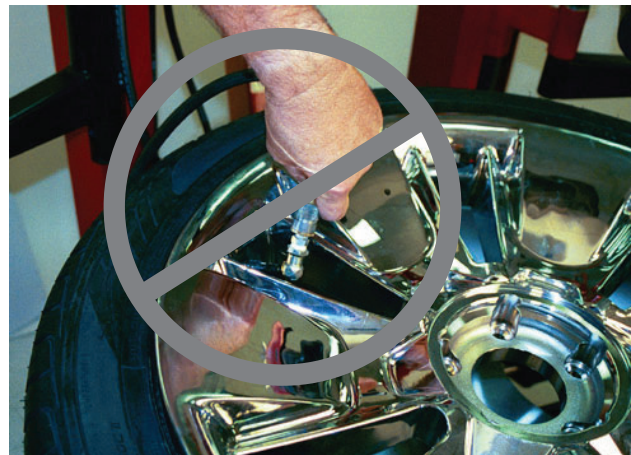

Figure 28 - Do Not Use a Hand-held Style Air Chuck

! DANGER

Explosion Hazard

Never exceed 40 PSI while seating beads. If you use more than 40 PSI always use safety cage.

Remember R.I.M.

(see page iv and back cover)

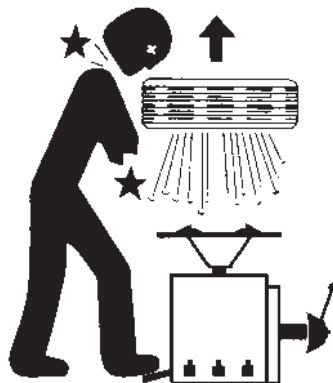

! DANGER

Explosion Hazard
Never inflate tire above manufacturer's recommended pressure after bead is seated.

Stages of Inflation on a Conventional Tire and Rim

Review these descriptions and diagrams carefully. Refer to them as necessary during bead sealing, bead seating, and inflation to verify that you are proceeding properly and safely.

Bead Sealing

Bead sealing is the process of capturing air pressure between the tire and the rim. The tire will usually contain about 1/2 to 2 PSI at initial bead seal.

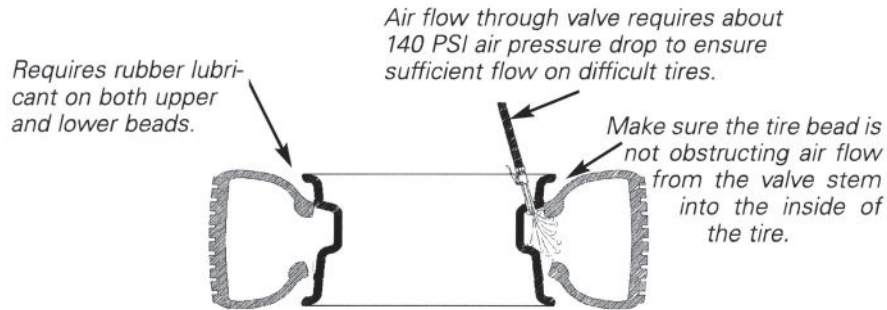

Bead Seating

Bead seating usually occurs on the long tapered side of the wheel first and the shorter side last. Bead seating will usually require at least 7 PSI in the tire. 40 PSI is the maximum safe pressure at this stage regardless of tire operating pressure. For tires requiring more than 40 PSI to bead seat use safety cage.

Most European import cars and many aftermarket alloy wheels are very tight and can be difficult to bead seat. Also note that asymmetrical hump and run-flat tires are extremely difficult to bead seat. Follow tire manufacturer's recommended procedure for bead seating.

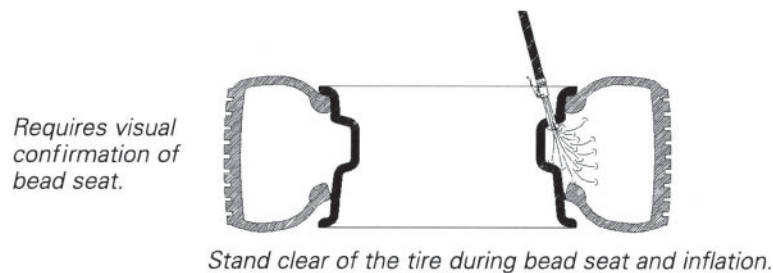

Inflation

After the beads are seated, the tire is ready to be inflated. Do not inflate the tire above the manufacturer's recommended pressure as stamped on the tire sidewall. The typical inflation pressure for automobile tires is between 24 and 45 PSI. Light truck inflation pressure typically covers a wider range.

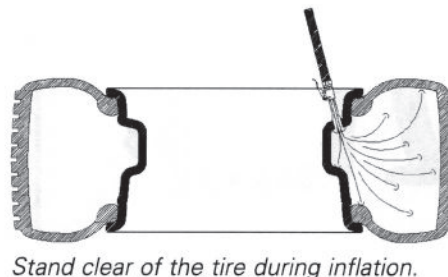

Mismatched Tires and Wheels

Never mount and inflate mis-matched tires and wheels.

! DANGER

Mismatched tire and wheel combinations will explode, if you attempt to force a bead seat, causing personal injury or death to operator and/or bystanders.

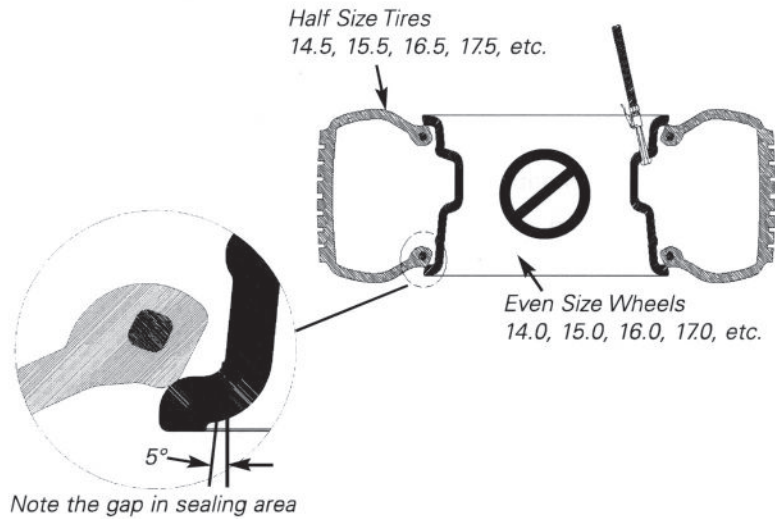
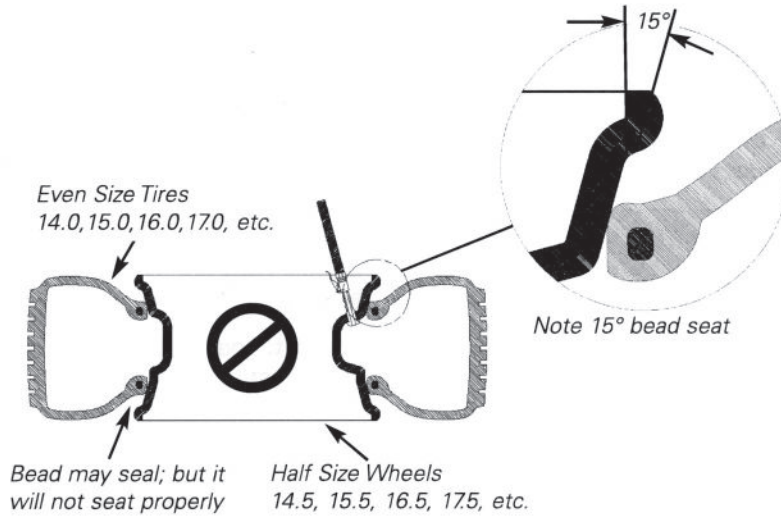

NOTE: Sometimes, regular inflation may not be enough to seat the bead of tubeless tires. This problem may be solved by using the optional accessory TUBELESS INFLATING DEVICE.

Tubeless Tire Inflation

In order to properly use the optional Tubeless Inflating Device:

Press the safety valve against the rim border, push the activating button on the handle to blast air and press the inflating pedal **4** to provide air to the wheel valve.

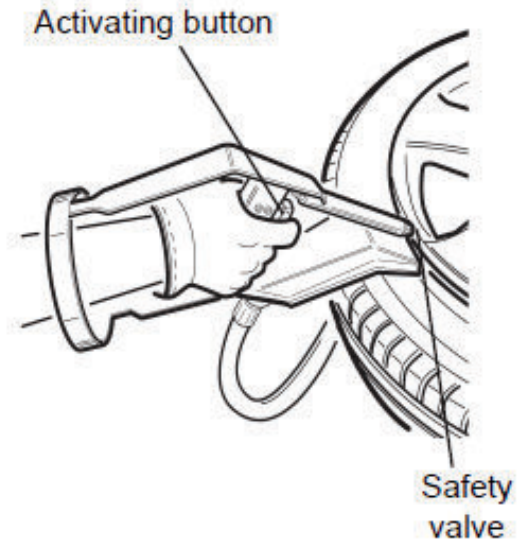

During the inflation stages (and especially during the bead seating operation), you must wear appropriate personal protective equipment to protect your hearing from possible blast injuries and from noise levels that sometimes exceed the permitted threshold.



Also use appropriate protection equipment to protect your eyes from possible debris that might fly due to the high pressure air involved in tire bead seating.

Due to the high pressure air that comes out of the jet when operating the inflating device, hold the handle firmly with your hand to avoid any backlash.

Standard Accessories



Lube Paste Bucket
(PN 8183710)



Brush
(PN 85000850)



X 3

Plastic protections for mounting/demounting tool
(PN 85000850)



X 2

Plastic protections for Smart Lock centering cone
(PN 89231516)



X 2

Rubber protections for clamping chuck
(PN 89231517)



X 2

Plastic protections for clamping chuck driving pin
(PN 89231518)



Plastic cone Ø 70 mm for clamping special alloy rims
(PN 83040730)



Manual Bead Depressor
(PN 89237711)



Bracket Pin
• pin (PN 83036303)
• washer (PN 83040636)
• nut (PN 84394168)

Standard Accessories (cont.)



Adjustment knob for Smart Lock

(PN 82041474)



Cleaning brush for Smart Lock and clamping chuck inner surface

(PN 84292291)



O rings for Smart Lock

- (1) (PN 84293252)
- (2) (PN 84298601)



Air lubricator, air filter/water trap

(PN 82041007)



Wheel lifter for wheel positioning and centering onto clamping chuck. Lift capacity: 176 lb. (80 kg.)

(PN 89240910)



Tubeless Inflation Device external kit

(PN 89241008)



3 Pin Extensions

- (1) 33mm (PN 83032133)
- (2) 72mm (PN 83031335)

Optional Accessories



Wheel clamping adaptor, allows clamping reverse mounted wheels, wheels with no center hole and special wheels (BMW rims). Suitable to lock any rim with any holes-number onto the clamping chuck. (PN 89242832)

Reverse mounted wheels

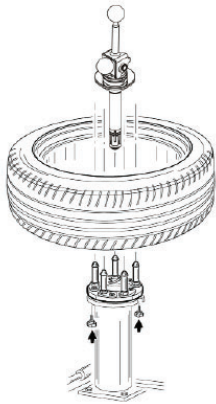

Wheels with no center hole

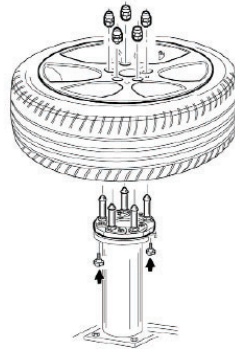

Special rims

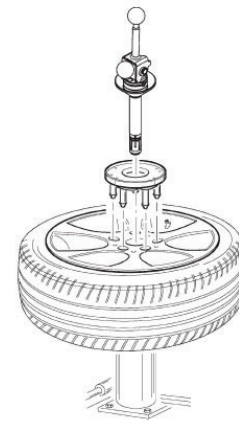

Truck cone kit, allows clamping VAN and LCV wheels with center hole diameter from 110 to 190 mm. (89219117)



Truck cone kit, allows clamping VAN and LCV wheels with center hole diameter from 140 to 220 mm. (89219126)



Double face cone for light trucks, allows clamping VANs and LCVs wheels with center hole diameter from 75 to 145 mm. (89234456)

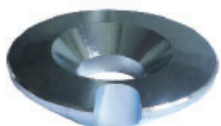

Cone for thin steel rims and center hole diameter from 75 to 120 mm. (89233680)

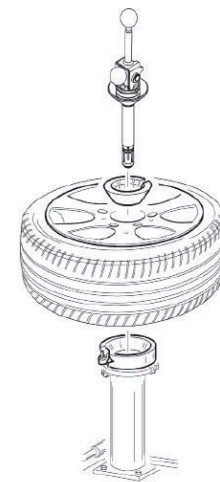

Maintenance

Standard Maintenance

Routine maintenance according to the following instructions is of crucial importance to ensure the correct operation and lasting life of the Tire Changer.



Unplug the unit from electrical power source and compressed air supply before servicing it.
Release the compressed air from the circuit by pressing the deflation button **14** for a few seconds.

On daily basis, keep the machine clean of any dirt to ensure the smooth movement of slides, carriages, and tools and to ensure the correct functioning of clamping chuck and locking systems.



On daily basis, check for worn or damaged plastic mounting tool inserts and plastic and rubber protections in order to protect alloy rims.

In case of wear or damage, replace them with new inserts and new protections.



Every 2-3 days, check the oil dropping into the cup (1 drop every 4-5 activations of the bead pressing arm or of the bead loosening system). If necessary, turn the screw on the top of the cup with a screwdriver.

Periodically check the oil level which should be kept above the container transparent part. If necessary, unscrew the cup and topoff by adding oil for pneumatic systems. (Chevron Regal® R&O 32)

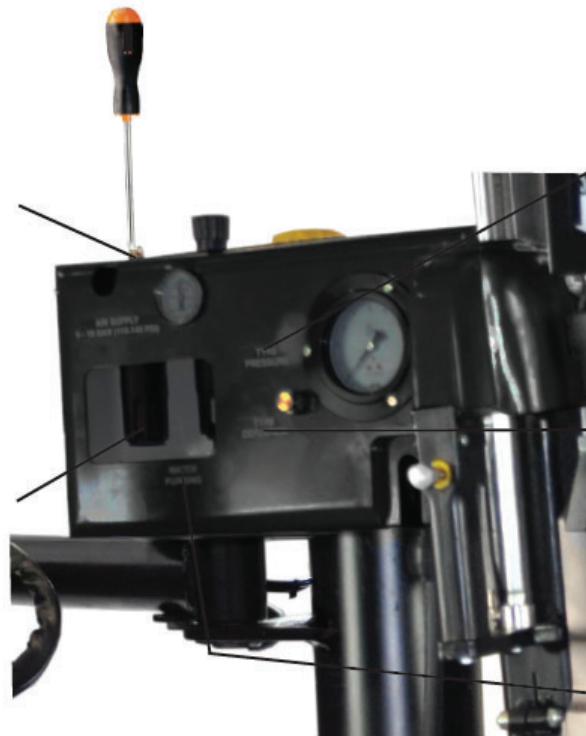

For long lasting correct functioning of the pressure limiter device, check on regular basis and discharge the condensation when needed.

If necessary, drain the condensation by turning the drain tap clockwise (keep the pneumatic supply ON to perform this adjustment).

On monthly basis, unplug the machine from pneumatic supply and remove the filter cup to clean it of possible solid impurities.

On periodical basis, clean the sliding guides of the bead loosener carriage with naphtha and lube them with oil or proper grease. Perform the same cleaning and lubricating actions on every junction and mechanical slide.

On periodical basis, check the tensioning of clamping chuck rotation driving belt. If necessary, use a 13mm wrench to loosen the mounting bolts of the motor support plate, then adjust the belt tension by turning the tensioning screw and retighten the mounting bolts.

Maintenance (cont.)

The regular cleaning and lubrication of the **SMART LOCK** components help ensure long-lasting functioning of the machine.

The replacement of the O-Rings is recommended every 12 - 18 months of **SMART LOCK** use.

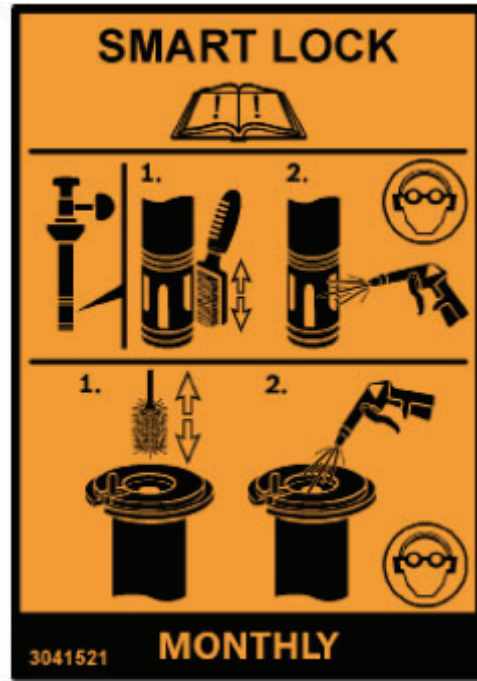

Machine Overhaul

Overhaul maintenance must be carried out by **factory authorized personnel ONLY**.

Defective parts should be replaced with authorized or approved replacement parts by factory authorized service personnel.

After 5 years from installation date, the Tire Changer must have all of its main components serviced to ensure correct functioning and operators safety.



The Manufacturer is not responsible for claims due to non-original spare parts or for damages caused by removal and tampering to the safety devices.

Removal or tampering with the safety devices (i.e. max. pressure limiter, pressure regulator) represents a breach of warranty.

Troubleshooting Chart

PROBLEM	CAUSE	SOLUTION
The clamping chuck does not rotate	<ol style="list-style-type: none"> 1) The power supply is missing; 2) Machine has not plugged correctly; 3) The fuses have blown; 4) The belt is loosened or broken; 5) The motor pulley is unscrewed; 6) The motor drive is not working properly; 7) The motor is defective or damaged. 	<ol style="list-style-type: none"> 1) Check the wall socket; 2) Check the machine plug is connect properly or if the plug wires are well connected. 3) Replace the fuses; 4) Tension or replace the belt; 5) Tighten the pulley screw; 6) Re-connect the foot control; 7) Replace the motor.
After the foot control releasing, the clamping chuck motor rotates at one speed only or just in one direction	<ol style="list-style-type: none"> 1) The foot-control has not been set up or adjusted correctly; 2) The micro-switches screws are unscrewed or missing; 3) The micro-switch is damaged or defective; 4) The foot control spring is damaged or loosened; 	<ol style="list-style-type: none"> 1) Adjust the clamping chuck rotation control pedal; 2) Tighten the screws where necessary or replace the missing ones; 3) Replace the micro switch; 4) Replace the spring.
The clamping chuck motor rotates at one speed only or just in one direction	<ol style="list-style-type: none"> 1) The micro switch is damaged or defective; 2) The micro switched is not connected properly; 3) The motor is damaged; 4) The motor wires are not connected. 	<ol style="list-style-type: none"> 1) Replace the micro switch; 2) Check the inverter wire and connect it if necessary; 3) Replace the motor; 4) Check and connect the motor wire.
The clamping chuck rotates but the wheel stays still	<ol style="list-style-type: none"> 1) Smart Lock system is not clamping 2) The driving pin is not holding. 	<ol style="list-style-type: none"> 1) Check the system is clamping correctly; 2) Position the pin properly.
The bead loosener disk does not move vertically or it moves slowly	<ol style="list-style-type: none"> 1) The air supply is missing; 2) The control valve is damaged; 3) The silencers are blocked; 4) The cylinder seal is damaged; 5) The valve is damaged or defective. 	<ol style="list-style-type: none"> 1) Check the net pressure; 2) Replace the valve; 3) Clean up the silencers or replace them; 4) Replace the seals; 5) Replace the valve.
The bead loosener disk does not move horizontally or it moves slowly	<ol style="list-style-type: none"> 1) The air supply is missing; 2) The control valve is damaged; 3) The silencers are blocked; 4) The cylinder seal is damaged; 5) The valve is damaged or defective 	<ol style="list-style-type: none"> 1) Check the net pressure; 2) Replace the valve; 3) Clean up the silencers or replace them; 4) Replace the seals; 5) Replace the valve

Troubleshooting Chart (cont.)

PROBLEM	CAUSE	SOLUTION
The bead loosener disk positions itself correctly but does not perform the "over run"	<ol style="list-style-type: none"> 1) The air supply is missing; 2) The control valve is damaged or defective; 3) The cylinders seals are damaged; 4) Movement is not activated; 5) The over run switch is damaged; 6) The valve damaged or defective 	<ol style="list-style-type: none"> 1) Check net pressure; 2) Replace the control valve; 3) Replace the seals; 4) Rotate the switch; 5) Replace the switch; 6) Replace the valve.
Bead loosener locking device does not release	<ol style="list-style-type: none"> 1) The air supply is missing; 2) The control valve is damaged; 3) The silencers are blocked; 4) The cylinder seal is damaged; 5) The valve is damaged or defective. 	<ol style="list-style-type: none"> 1) Check net pressure; 2) Replace the valve; 3) Clean up the silencers or replace them; 4) Replace the seals; 5) Replace the valve.
The tool does not move vertically	<ol style="list-style-type: none"> 1) The air supply is missing; 2) The supply union is not connected; 3) The feeding hoses are damaged or squeezed; 4) Control valve is damaged; 5) The silencers are blocked; 6) The cylinder seal is damaged. 	<ol style="list-style-type: none"> 1) Check net pressure; 2) Plug the union carefully or check the air hoses passage; 3) Replace the feeding hoses; 4) Replace the valve; 5) Clean up the silencers or replace them; 6) Replace the seals.
The wheel lifter does not move or move slowly	<ol style="list-style-type: none"> 1) The air supply is missing; 2) The control valve is damaged; 3) The silencers are blocked; 4) The cylinder seals are damaged. 	<ol style="list-style-type: none"> 1) Check net pressure; 2) Replace the valve; 3) Clean up the silencers or replace them; 4) Replace the seals.
The wheel lifter does not stop	<ol style="list-style-type: none"> 1) The control valve is damaged; 2) The foot control spring is damaged 	<ol style="list-style-type: none"> 1) Replace the valve; 2) Replace the spring.
The inflating device does not work	<ol style="list-style-type: none"> 1) The air supply is missing; 2) The control valve is damaged; 3) The pressure valve is damaged. 	<ol style="list-style-type: none"> 1) Check the net pressure; 2) Replace the valve; 3) Replace the valve.
The tilting tower does not move or moves slowly	<ol style="list-style-type: none"> 1) The silencers are blocked; 2) The silencers have not been adjusted; 3) Foot control release spring is damaged; 4) The compressed air supply is missing; 5) Column sleeve too loosened or too tighten 	<ol style="list-style-type: none"> 1) Clean up or replace the silencers; 2) Adjust silencers; 3) Replace foot control release spring; 4) Check or restore pneumatic supply; 5) Adjust column sleeve.
The tool hit the rim during mounting operations	<ol style="list-style-type: none"> 1) The locking plate has not been adjusted properly or is defective 2) The unlocking plate springs are damaged 3) Smart Lock is loosened 	<ol style="list-style-type: none"> 1) Adjust or replace the locking plate 2) Replace the unlocking plate springs 3) Tighten Smart Lock

NOTES

ONE WORD FOR SAFETY

R.I.M.

READ INSPECT MOUNT

READ...

Mounting and inflating the wrong size tire can get you hurt. *Read* the size on the tire and make sure it matches the rim. Be especially careful about putting a smaller tire on a larger rim, such as a 16-inch tire on a 16.5-inch rim.

Inflation of a mismatched tire and rim can cause an explosion.

INSPECT...

Before you put any tire on a rim, *inspect* the rim for rust, tough spots, bent edges, or cracks that could prevent the tire from seating right. If you spot any of these problems, don't mount the tire until the rim has been checked by your shop foreman.

Inspect the tire for bead damage.

MOUNT...

Once you've made sure the tire is OK and the right size and the rim is OK, *mount* the tire safely. NEVER, ever lean over the tire when you're inflating it. If a tire does explode, it will go straight up. You don't want to be over the tire if that happens. Also, never over-inflate the tire, even if the bead doesn't seat. Never inflate over 40 PSI. If the tire hasn't seated, something is wrong. Deflate the tire and check it and the rim again. If it doesn't work the second time, try another tire.

BE CAREFUL OF THESE SITUATIONS:

- | | | | |
|------------------------------------------------------------------------|-----------------------------------------------------------------------------------------------------------|-----------------------------------------------------------------------------------------------------------------------------------|---------------------------------------------------------------------------------------------------------------|
| 1. Damaged Bead or Beads. | 4 A. Mismatched.
<i>(A mis-match of a 16-inch tire to a 16.5-inch rim causing an explosion)</i> | 5. Walk-In Tire and Rim. | 8. Standing Clear.
<i>(Never put any part of your body over the tire changer during inflation.)</i> |
| 2. Rusty Wheels.
<i>(particularly in the bead seat area)</i> | 4 B. Mismatched.
<i>(16.5-inch tire on a 16-inch rim)</i> | 6. Back Injuries. | 9. Beads will not Seat at 40 PSI. |
| 3. Bent or Cracked Wheels. | | 7. Hand or Finger Injuries.
<i>(Hands or fingers too close to inflating tire or bead seats which may cause injury.)</i> | 10. Improper Inflation. |

Remember R.I.M. (Read, Inspect, Mount) for every tire.



FAILURE TO READ AND FOLLOW ALL WARNINGS AND INSTRUCTIONS IN THIS MANUAL CAN LEAD TO SERIOUS PERSONAL INJURY OR DEATH TO OPERATOR OR BYSTANDER.

THE OWNER IS RESPONSIBLE FOR MAINTAINING THE OPERATION INSTRUCTIONS AND DECALS FOR OPERATOR REFERENCE. FOR ADDITIONAL COPIES, CONTACT HENNESSY INDUSTRIES, INC., 1601 J.P. HENNESSY DRIVE, LAVERGNE, TENNESSEE, 37086 - (800) 688-6359.

TIRE FAILURE UNDER PRESSURE IS HAZARDOUS! This tire changer Will Not Restrain Exploding Tires, rims or other related equipment.

TIRES CAN EXPLODE, ESPECIALLY IF INFLATED BEYOND SPECIFIED LIMITS. DO NOT EXCEED TIRE MANUFACTURERS RECOMMENDED AIR PRESSURE.

AN EXPLODING TIRE, RIM, OR BEAD SEATING EQUIPMENT MAY PROPEL UPWARD AND OUTWARD WITH SUFFICIENT ENERGY TO CAUSE SERIOUS INJURY OR DEATH TO OPERATOR AND/OR BYSTANDERS.